

TABLE OF CONTENTS

| | |
|----------------------------------------------|-----------|
| 01 Introduction | 1 |
| 1.1 Operation Modes Introduction..... | 1 |
| 1.2 Safety and Warning..... | 2 |
| 1.3 Product Overview | 4 |
| 02 Installation Instructions | 5 |
| 2.1 Unacceptable Installations..... | 5 |
| 2.2 Packing List | 6 |
| 2.3 Mounting..... | 7 |
| 2.3.1 Installation Requirements | 7 |
| 2.3.2 Installing the Inverter | 8 |
| 2.4 Electrical Wiring Connection | 10 |
| 2.4.1 PE Cable Connection | 10 |
| 2.4.2 Battery Wiring Connection | 11 |
| 2.4.3 On-Grid&Back-up Connection..... | 12 |
| 2.4.3 Smart Meter & CT Connection | 15 |
| 2.4.4 Anti-Reverse Function Connection | 17 |
| 2.4.5 WiFi Module Connection..... | 18 |
| 2.5 DRED & Remote Shutdown Connection | 18 |
| 2.6 Earth Fault Alarm Connection..... | 19 |
| 03 Manual Operation | 23 |
| 3.1 Wi-Fi Configuration | 23 |
| 3.2 PV Master | 24 |
| 3.3 SEMS Portal | 25 |
| 3.4 CEI Auto-Test Function..... | 25 |
| 3.5 Startup/shutdown Procedure | 25 |
| 04 Other | 26 |
| 4.1 Error Messages..... | 26 |
| 4.2 Troubleshooting | 28 |

4.3 Disclaimer32

4.4 Technical Parameters34

4.4 Quick Checklist To Avoid Dangerous Conditions.....38

Appendix 39

01 Introduction

The inverter is designed for both indoor and outdoor use, which could be used with or without existing grid-tied inverter systems to store energy using batteries.

Energy produced from the grid-tied inverters will be used to optimize self-consumption, excess will be used to charge the battery, anymore could be exported to the grid. Loads will be supported in priority by grid-tied system, then battery power, if more power is needed, energy will be imported from the grid.

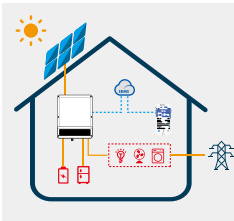

The introduction describes a general behavior of the system. The operation mode can be adjusted on PV Master App depending on the system layout. Below are the general operation modes for the system:

1.1 Operation Modes Introduction

The system normally has the following operation modes based on your configuration and layout conditions.

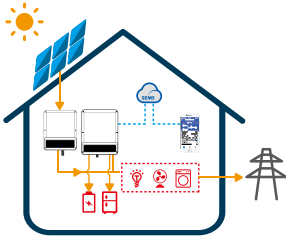

Mode I
Energy from grid-tied inverters optimize loads, excess will be used to charge the battery, anymore will be exported to the grid.

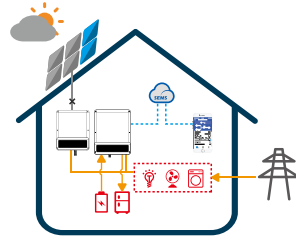

Mode II
When energy from grid-tied inverters is weak, battery will discharge to support the load in priority together with the grid.

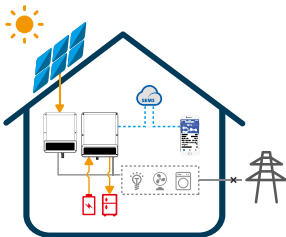

Mode III
When grid power fails, battery will discharge to support back-up loads.

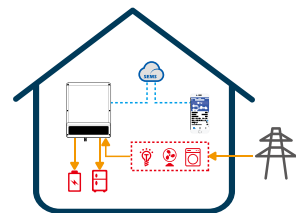

Mode IV
Battery could be charged by grid, and charge time/power could be set flexibly on PV Master App.

1.2 Safety and Warning

The inverter of Jiangsu Goodwe Power Supply Technology Co.,Ltd (hereinafter called as GoodWe) strictly complies with related safety rules for product design and testing. Please read and follow all the instructions and cautions on the inverter or user manual during installation, operation or maintenance, as any improper operation might cause personal or property damage.



These servicing instructions are for use by qualified personnel only. To reduce the risk of electric shock, do not perform any servicing other than that specified in the operating instructions. Ces instructions d'entretien sont destinées uniquement au personnel qualifié. Pour réduire le risque de choc électrique, n'effectuez aucun service autre que celui spécifié dans les instructions d'exploitation.

Symbol Explanation



Caution!

Failure to observe any warnings contained in this manual may result in injury.



Danger - high voltage and electric shock!



Danger - hot surface!



The components of the product can be recycled.



This side up! This package must always be transported, handled and stored in such a way that the arrows always point upwards.



No more than six (6) identical packages being stacked on each other.



Products shall not be disposed as household waste.



Fragile - The package/product should be handled carefully and never be tipped over or slung.



Refer to the operating instructions.



Keep dry! The package/product must be protected from excessive humidity and must be stored under cover.



This symbol indicates that you should wait at least 5mins after disconnecting the inverter from the utility grid and from the PV panel before touching any inner live parts.



CE mark.

Safety Warnings

Any installation and operation on inverter must be performed by qualified electricians, in compliance with standards, wiring rules or requirements of local grid authorities or companies (like AS 4777 and AS/NZS 3000 in Australia).

Prohibit inserting and pulling the AC and DC terminals when the inverter is running.

Before any wiring connection or electrical operation on inverter, all DC and AC power must be disconnected from inverter for at least 5 minutes to make sure inverter is totally isolated to avoid electric shock.

The temperature of inverter surface might exceed 60°C during operation, so please make sure it has cooled down before touching it, and make sure the inverter is out of reach of children.

Do not open the inverter's cover or change any components without manufacturer's authorization, otherwise the warranty commitment for the inverter will be invalid.

Usage and operation of the inverter must follow instructions in this user manual, otherwise the protection design might be impaired and warranty commitment for the inverter will be invalid.

Appropriate methods must be adopted to protect inverter from static damage. Any damage caused by static is not warranted by manufacturer.

Battery negative(BAT-) on inveter side is not grounded as default design. Connecting BAT- to EARTH are strictly forbidden.

The inverter, with built-in RCMU, will exclude possibility of DC residual current to 6mA, thus in the system an external RCD (type A) can be used($\geq 30\text{mA}$).

In Australia, the inverter internal switching does not maintain neutral integrity, which must be addressed by external connection arrangements like in the system connection diagram.





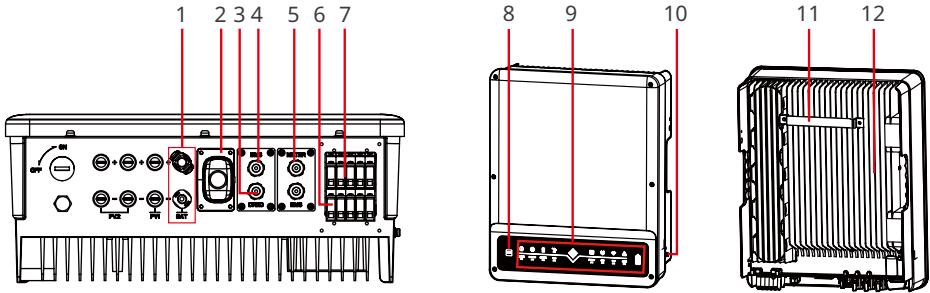







In Australia, output of back-up side in switchbox should be labeled "Main Switch UPS Supply", the output of normal load side in switch box should be labeled "Main Switch Inverter Supply".

















1.3 Product Overview



- | | | |
|---------------------------|------------------------------|----------------------------|
| 1. Battery Terminal (BAT) | 2. Module Port (WiFi or LAN) | 3. DRED Communication Port |
| 4. BMS Communication Port | 5. Meter Communication Port | 6. Back-Up Port |
| 7. On-Grid Port | 8. Wi-Fi Reset | 9. Indicators |
| 10. PE Terminal | 11. Mounting Plate | 12. Heat Sink |

LED Indicators

| No. | Indicator | Status | Explanation |
|-----|-----------|-------------------------------------------------------------------------------------|--------------------------------------------|
| 1 | SYSTEM |  | ON = SYSTEM IS READY |
| 2 | |  | BLINK = SYSTEM IS STARTING UP |
| 3 | |  | OFF = SYSTEM IS NOT OPERATING |
| 4 | BACK-UP |  | ON = BACK-UP IS READY / POWER AVAILABLE |
| 5 | |  | OFF = BACK-UP IS OFF / ON POWER AVAILABLE |
| 6 | BATTERY |  | ON = BATTERY IS CHARGING |
| 7 | |  | BLINK1 = BATTERY IS DISCHARGING |
| 8 | |  | BLINK2 = BATTERY IS LOW / SOC IS LOW |
| 9 | |  | OFF = BATTERY IS DISCONNECTED / NOT ACTIVE |
| 10 | GRID |  | ON = GRID IS ACTIVE AND CONNECTED |
| 11 | |  | BLINK = GRID IS ACTIVE BUT NOT CONNECTED |
| 12 | |  | OFF = GRID IS NOT ACTIVE |

| No. | Indicator | Status | Explanation |
|-----|-----------|-----------------------------------------------------------------------------------|---------------------------------------------------------|
| 13 | ENERGY |  | ON = CONSUMING ENERGY FROM GRID / BUYING |
| 14 | |  | BLINK 1 = SUPPLYING ENERGY TO GRID / ZEROING |
| 15 | |  | BLINK 2 = SUPPLYING ENERGY TO GRID / ZEROING |
| 16 | |  | OFF = GRID IS NOT CONNECTED OR SYSTEM NOT OPERATING |
| 17 | COM |  | ON = BMS AND METER COMMUNICATION OK |
| 18 | |  | BLINK1 = METER COMMUNICATION OK, BMS COMMUNICATION FAIL |
| 19 | |  | BLINK2 = METER COMMUNICATION OK, BMS COMMUNICATION FAIL |
| 20 | |  | OFF = BMS AND METER COMMUNICATION FAIL |
| 21 | WiFi |  | ON = WiFi CONNECTED / ACTIVE |
| 22 | |  | BLINK 1 = WiFi SYSTEM RESETTING |
| 23 | |  | BLINK 2 = WiFi NOT CONNECT TO ROUTER |
| 24 | |  | BLINK4 = WiFi SERVER PROBLEM |
| 25 | |  | OFF = WiFi NOT ACTIVE |
| 26 | FAULT |  | ON = FAULT HAS OCCURRED |
| 27 | |  | BLINK1 = OVERLOAD OF BACK-UP OUTPUT / REDUCE LOAD |
| 28 | |  | OFF = NO FAULT |

02 Installation Instructions

2.1 Unacceptable Installations



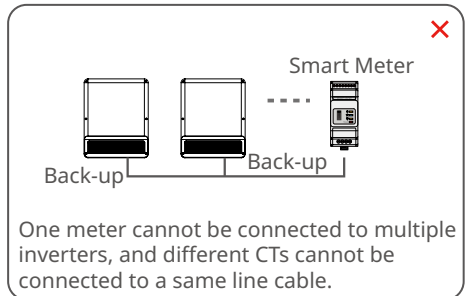
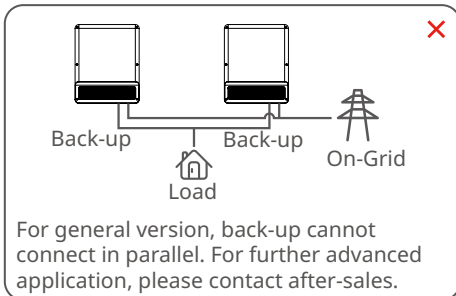

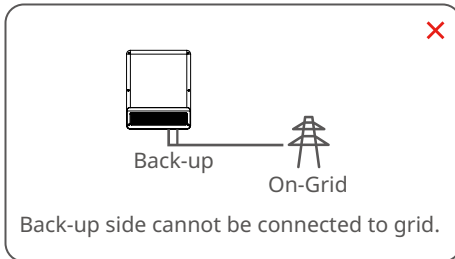
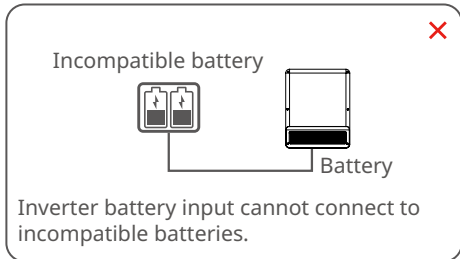
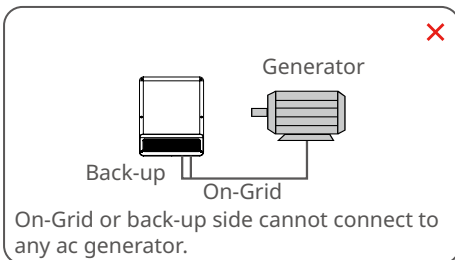
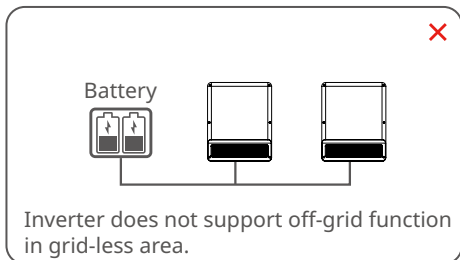





Please avoid the following installations which will damage the system or the Inverter. The following installations should be avoided. Any damage caused will not be covered by the warranty policy.





2.2 Packing List

Upon receiving the inverter, please check if any of the components as shown below are missing or broken.

| | | | | | |
|--------------------------------------------------------------------------------------------------------|---------------------------------------------------------------------------------------------------------------|--------------------------------------------------------------------------------------------------------|--------------------------------------------------------------------------------------------------------------------|------------------------------------------------------------------------------------------------------|-------------------------------------------------------------------------------------------------------|
|  <p>Inverter</p> |  <p>Wall-mounted Bracket</p> |  <p>Smart Meter</p> |  <p>BAT Connector</p> |  <p>AC Cover</p> |  <p>PIN Terminal</p> |
|  <p>PE Terminal</p> |  <p>Expansion bolts</p> |  <p>Fixed Screw</p> |  <p>WiFi Module and Remover</p> |  <p>Documents</p> | |

2.3 Mounting

2.3.1 Installation Requirements

Installation Environment Requirements

1. Do not install the equipment in a place near flammable, explosive, or corrosive materials.
2. Install the equipment on a surface that is solid enough to bear the inverter weight.
3. Install the equipment in a well-ventilated place to ensure good dissipation. Also, the installation space should be large enough for operations.
4. The equipment with a high ingress protection rating can be installed indoors or outdoors. The temperature and humidity at the installation site should be within the appropriate range (60°C for outdoor unconditioned with solar effects).
5. Install the equipment in a sheltered place to avoid direct sunlight, rain, and snow. Build a sunshade if it is needed.
6. Do not install the equipment in a place that is easy to touch, especially within children's reach. High temperature exists when the equipment is working. Do not touch the surface to avoid burning.
7. Install the equipment at a height that is convenient for operation and maintenance, electrical connections, and checking indicators and labels.
8. Install the equipment away from electromagnetic interference.

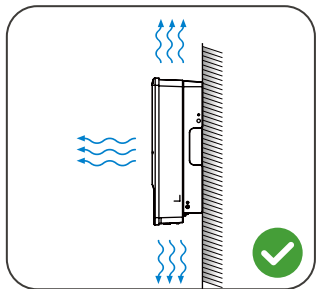
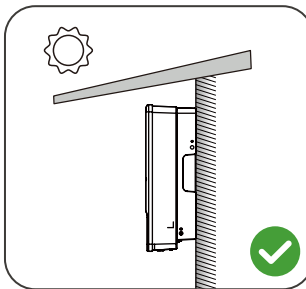
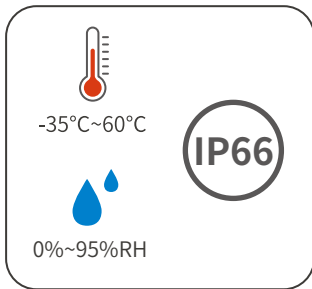
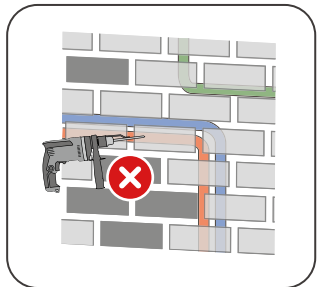
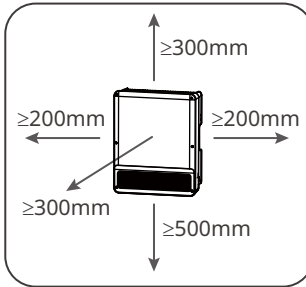



Mounting Support Requirements

- The mounting support shall be nonflammable and fireproof.
- Make sure that the support surface is solid enough to bear the product weight load.
- Do not install the product on the support with poor sound insulation to avoid the noise generated by the working product, which may annoy the residents nearby.

Installation Angle Requirements

- Install the inverter vertically or at a maximum back tilt of 15 degrees.
- Do not install the inverter upside down, forward tilt, back forward tilt, or horizontally.

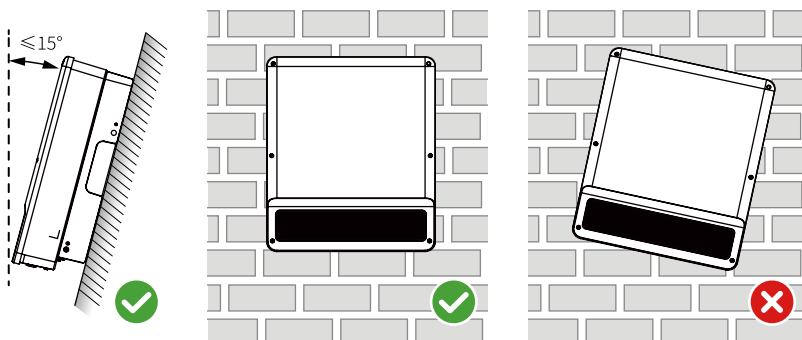

2.3.2 Installing the Inverter

The inverter is suitable for mounting on concrete or other non-combustible surfaces only.

1

Please use the mounting bracket as a template to drill 4 holes in the correct positions (e.g. 10mm in diameter and 80mm in depth). Use the expansion bolts in the accessory box and tightly attach the mounting bracket to the wall.

Note: The bearing capacity of the wall must be greater than 25kg. Otherwise, the wall may not be able to prevent the inverter from dropping.

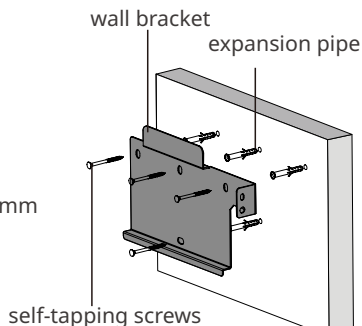
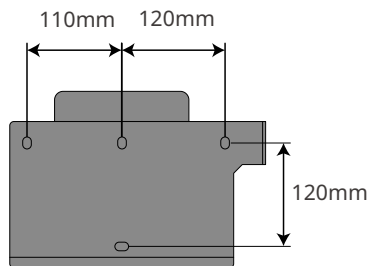

2

Carry the inverter by holding the heat sink on two sides and place the inverter on the mounting bracket.

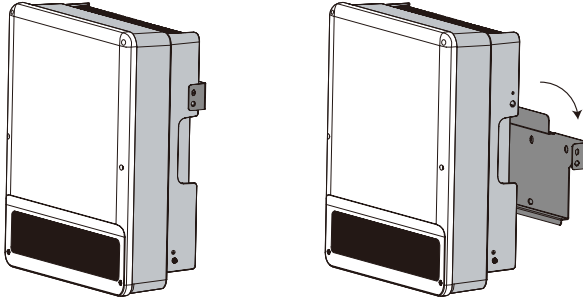

3

The inverters can be locked for anti-theft purposes if this is necessary for individual requirements.

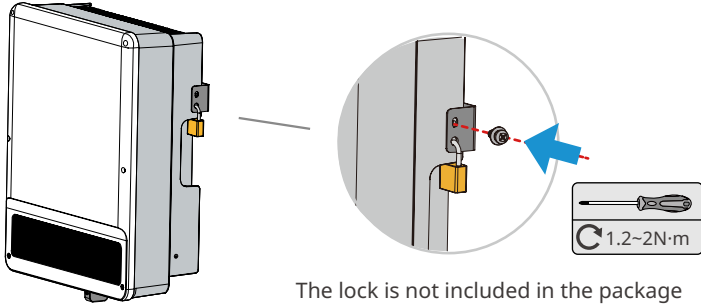

The lock is not included in the package and can be purchased by the user.



2.4 Electrical Wiring Connection

DANGER

- Disconnect the AC output switch of the inverter to power off the equipment before any electrical connections. Do not work with power on. Otherwise, an electric shock may occur.
- Perform electrical connections in compliance with local laws and regulations. Including operations, cables, and component specifications.
- If the tension is too large, the cable may be poorly connected. Reserve a certain length of the cable before connecting it to the inverter cable port.

NOTICE

- Wear personal protective equipment like safety shoes, safety gloves, and insulating gloves during electrical connections.
- All electrical connections should be performed by qualified professionals.
- Cable colors in this document are for reference only. The cable specifications should meet local laws and regulations.

2.4.1 PE Cable Connection

WARNING

- The PE cable connected to the enclosure of the inverter cannot replace the PE cable connected to the AC output port. Both of the two PE cables must be securely connected.
- Make sure that all the grounding points on the enclosures are equipotential connected when there are multiple inverters.
- To improve the corrosion resistance of the terminal, it is recommended to apply silica gel or paint on the ground terminal after installing the PE cable.
- The PE cable should be prepared by customers. Recommended specifications:
 - Type: single-core outdoor copper cable
 - Conductor cross-sectional area $S \geq 4\text{mm}^2$

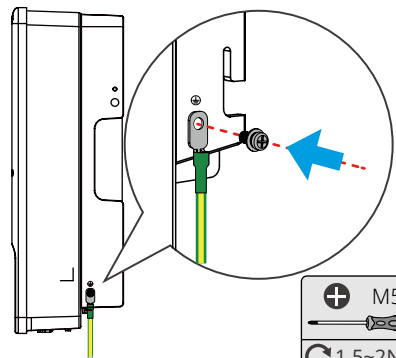
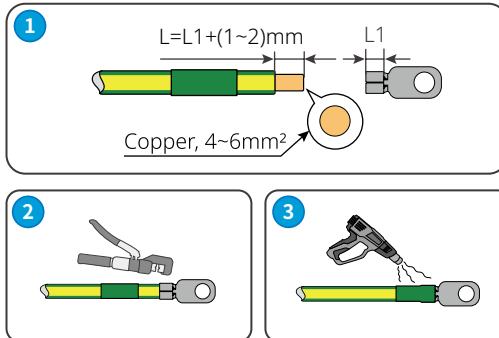

2.4.2 Battery Wiring Connection

- Please be careful against any electric shock or chemical hazard.
- Make sure there is an external DC breaker ($\geq 40A$) connected for battery without build-in DC breaker.



Make sure that the battery switch is off and battery nominal voltage meets the inverter specification before connecting battery to inverter. Make sure inverter is totally isolated from PV and AC power.

Please follow the requirements and steps below strictly. Using improper wire may cause bad contact and high impedance, which is dangerous to the system.

- Use the right BAT plugs from the accessory box.
- The maximum battery current is 25A, please use the tin-plated cables of which the cross section ranges from 4 to 6 mm² (AWG 10). Battery cable requirements are shown as below.

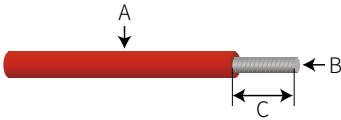

| Grade | Description | Value |
|-------|------------------------|---------------------|
| A | Outside diameter | 5.5-8.0 mm |
| B | Conductor core section | 4-6 mm ² |
| C | Conductor core length | 15 mm |

Battery wiring connection process

+: Positive polarity

-: Negative polarity

- 1** Prepare BAT cables and BAT plugs.

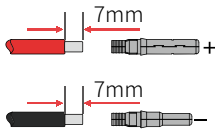

Note

- Please use BAT plugs and connectors in the accessory box.
- BAT cable should be standard, 4-6mm² BAT cable.

- 2** Connect BAT cables to BAT connectors.

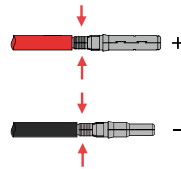

Note

- BAT cable must be tightly crimped into the connectors.
- There will be a click sound if connectors are inset correctly into BAT plugs.

3 Screw the cap on and plug onto inverter side.

Note: There will be a click sound if connectors are inset correctly into BAT plugs.

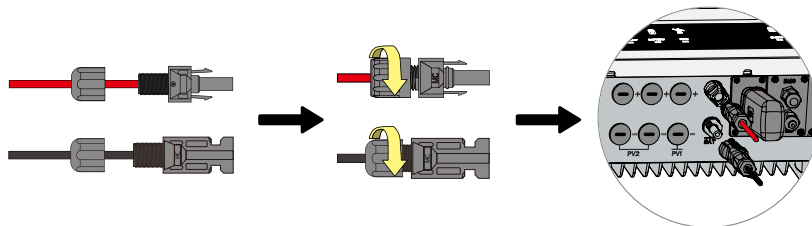

Note: For the compatible lithium batteries (Pylon/BYD) connection, please refer to battery connection.

2.4.3 On-Grid&Back-up Connection

An external AC breaker is needed for on-grid connection to isolate the inverter from the utility grid when necessary.

The requirements for the on-grid AC breaker are shown below.

| Inverter Model | AC Breaker Specification |
|----------------|-------------------------------|
| GW5K-BT | 25A / 400V (e.g. DZ47-60 C25) |
| GW6K-BT | 25A / 400V (e.g. DZ47-60 C25) |
| GW8K-BT | 32A / 400V (e.g. DZ47-60 C32) |
| GW10K-BT | 32A / 400V (e.g. DZ47-60 C32) |

Note: The absence of AC breaker will lead to inverter damage if an electrical short circuit happens on grid side.

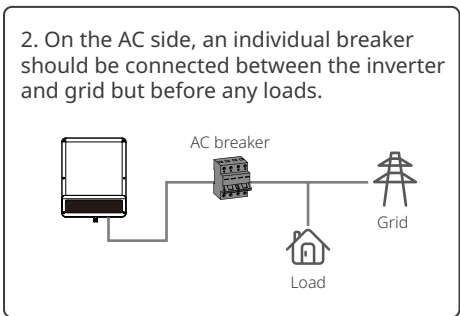
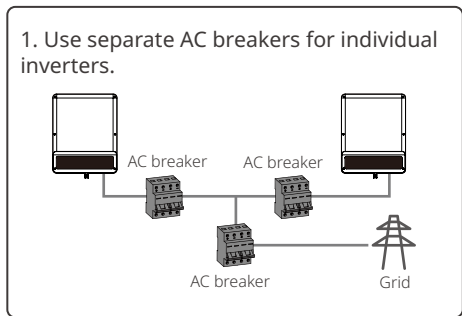

AC cable is required to connect to both on-grid and back-up side.



Make sure the inverter is totally isolated from any DC or AC power before connecting AC cable.

Note:

1. Neutral cable shall be blue, line cable shall be black or brown (preferred) and protective earth cable shall be yellow-green.
2. For AC cables, PE cable shall be longer than N&L cables, so in case that the AC cable slips or is taken out, the protecting earth conductor will be the last to take the strain.

1

Prepare the terminals and AC cables according to the correct table.

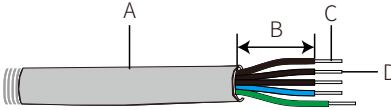

| Grade | Description | Value |
|-------|------------------------|---------------------|
| A | Outside diameter | 13-18 mm |
| B | Separated wire length | 20-25 mm |
| C | Conductor wire length | 7-9 mm |
| D | Conductor core section | 4-6 mm ² |

2

Place the AC cable through the terminal cover as shown in the figure.

Note: Please use the terminals in the accessory box.

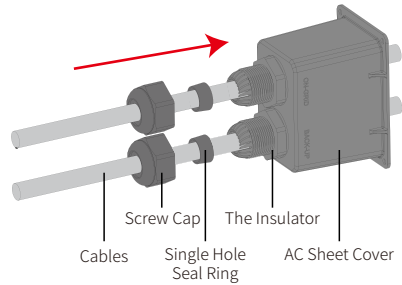

3

Press the connectors tightly on the cable conductor core.

Note: Make sure the cable jacket is not locked within the connector.

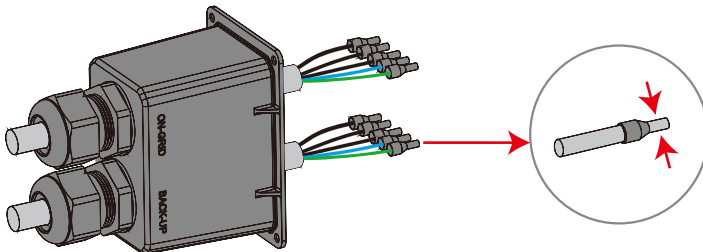



4

Use a screwing torque of 2.0–2.5Nm.

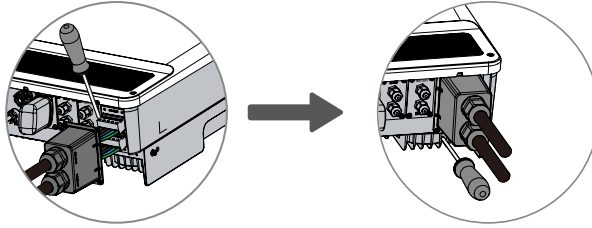

1. Connect the assembled AC cables to AC terminals with a fastening torque of approximately 2.0-2.5 Nm.

Note: (If the inverter has backup function) Connect the backup terminals before connecting the on-grid terminals. Make sure they are not connected to the wrong side.

2. Lock the cover and screw on the cap.

Special adjustable settings

The inverter has a field where the user can set functions, such as trip points, trip time, time of reconnection, active and invalid of QU curve, and PU curve. These functions can be adjusted by using special software. If interested, please contact the after-sales department.

Declarations for the backup function

The back-up output of inverters have over load ability.

For details please refer to the technical parameters of the inverter section.

And the inverter has self-protection derating at high ambient temperature.

The below statement lays out general policies governing the energy storage inverters.

1. For Hybrid inverters, the standard PV installation typically consists of the connection of the inverter with both panels and batteries. In case of systems not connected to the batteries, the Back-Up function is strongly not advised to use. GoodWe shall not cover the standard warranty and be liable for any consequences arising from users not following this instruction.
2. Under normal circumstances, the Back-Up switching time is less than 10 ms (the minimal condition to be considered as the UPS level). However, some external factors may cause the system to fail on Back-Up mode. As such, we recommend the users to be aware of conditions and follow the instructions as below:
 - Do not connect loads if they are dependent on a stable energy supply for a reliable operation
 - Do not connect the loads which may in total exceed the maximum Back-Up capacity
 - Try to avoid those loads which may create very high start-up current surges such as Inverter Air-conditioner, high-power pump etc.
 - Due to the condition of battery itself, battery current might be limited by some factors including but not limited to the temperature, weather etc.

Acceptable loads are shown below:

The inverters are able to supply over load output at it's Back-Up. For details please refer to the technical parameters. And the inverter has self-protection derating at high ambient temperature.

- Inductive Load: 1.5P non-frequency conversion air-conditioner can be connect to back-up side. Two or more non-frequency conversion air-conditioner connect to Back-Up side may cause UPS mode unstable.
- Capacitive Load: Total power $\leq 0.6 \times$ nominal power of model. (Any load with high inrush

- current at start-up is not accepted.)
- For complicated application, please contact after-sales.

Note:

For a convenient maintenance, an DP3T support could be installed on Back-Up and On-Grid side. Then it is adjustable to support load by Back-Up or by grid or just leave it there.

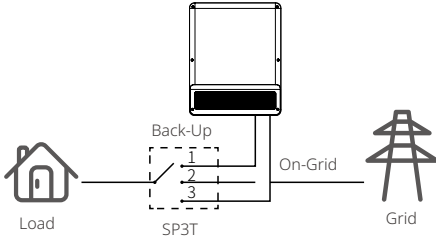

1. Back-up load is supplied from back-up side.
2. Back-up load is isolated.
3. Back-up load is supplied from grid side.

Declarations for backup overload protection

Inverter will restart itself as overload protection happens. The preparation time for restarting will be longer and longer (max one hour) if overload protection repeats. Take following steps to restart inverter immediately.

- Decrease Back-Up load power within max limitation.
- On PV Master > Advanced Setting > Click "Reset Back-Up Overload History"

2.4.3 Smart Meter & CT Connection

The single-phase Smart Meter with 2 CTs in product box is compulsory for the system installation, used to detect grid voltage and current direction and magnitude, further to instruct the operation condition of the inverter via RS485 communication.



Make sure the AC cable is totally isolated from AC power before connecting the Smart Meter and CT.

Note:

1. The Smart Meter and CT is well configured, please do not change any setting on smart meter.
2. CT must be connected on the same phase with smart meter power cable.
3. Please use the Smart Meter with CT in product box.
4. CT cable is 3m as default, could be extended to max 5m.
5. Smart Meter communication cable (RJ45) is attached on the inverter ("To Smart Meter" cable), could be extended to max 100m, and must use standard RJ45 cable and plug, as the diagram:

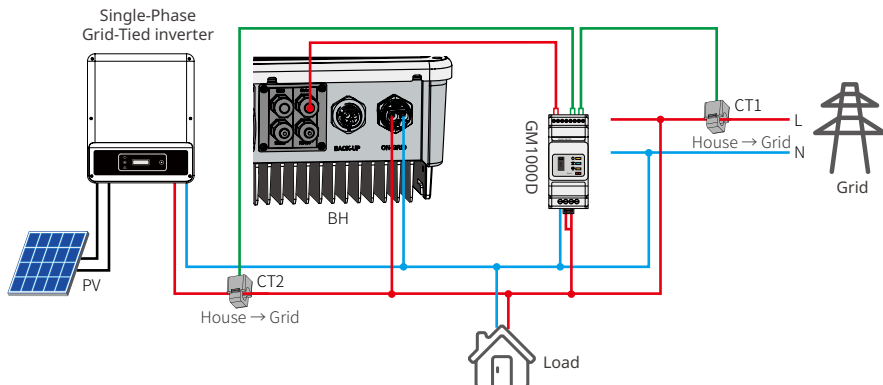

Detailed pin functions

BMS: CAN communication is configured by default. If 485 communication is used, please contact after-sales to replace with the corresponding communication line.

| Position | Color | BMS Function | Smart Meter Function | EMS |
|----------|----------------|--------------|----------------------|-------|
| 1 | Orange & white | 485_A2 | NC | 485_A |
| 2 | Orange | NC | NC | 485_B |
| 3 | Green & white | 485_B2 | 485_B1 | 485_A |
| 4 | Blue | CAN_H | NC | NC |
| 5 | Blue & white | CAN_L | NC | NC |
| 6 | Green | NC | 485_A1 | 485_B |
| 7 | Brown & white | NC | 485_B1 | NC |
| 8 | Brown | NC | 485_A1 | NC |

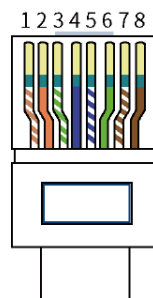

Smart Meter LED indications

| STATUS | OFF | ON | Blinking |
|--------|--------------------------------------------------------|-----------|-----------|
| POWER | Not working | Working | / |
| ENERGY | / | Importing | Exporting |
| COM | Single blink when data are transferred to the inverter | | |

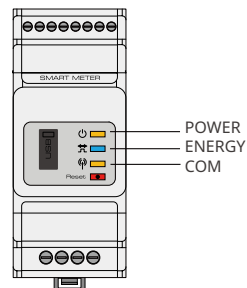

! Make sure AC cable is totally isolated from AC power before connecting Smart Meter & CT.

The Smart Meter with CT in product box is compulsory for the system installation, used to detect grid voltage and current direction and magnitude, further to instruct the operation condition of the inverter via RS485 communication.

Note:

1. The Smart Meter with CT is well configured, please do not change any setting on Smart Meter.
2. One Smart Meter can only be used for one inverter.
3. CT must be connected on the same direction as the CT indicated.

2.4.4 Anti-Reverse Function Connection

If the system (connected with grid-tied inverters) requires anti-reverse function, it is operable but please note:

1. This diagram is only for installation where has exporting power limit function requirement.
2. For anti-reverse function, will also need set on PV Master App > Advanced Setting > Power Limit.
3. This diagram only be reasonable if grid-tied inverter has anti-reverse function itself. And the power limitation value shall be set on grid-tied inverter.
4. When using anti-reverse function, it would buy about 100W from the grid.

Connection Diagram As Below:

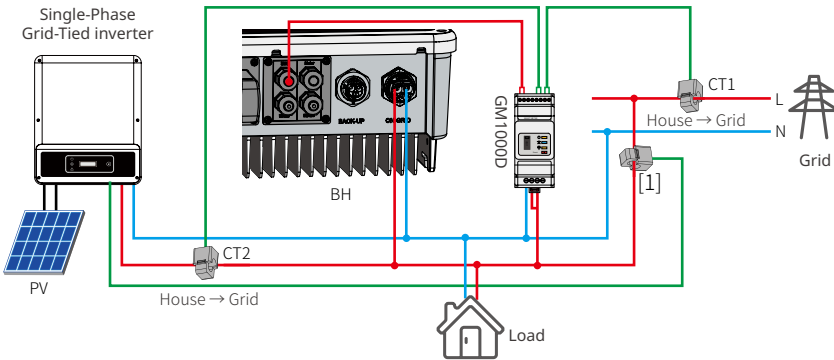

[1] This cable is a theoretical connection supporting anti-reverse function, which could be different for different grid-tied inverters.

2.4.5 WiFi Module Connection

WiFi Kit, Wi-Fi/LAN Kit module: optional

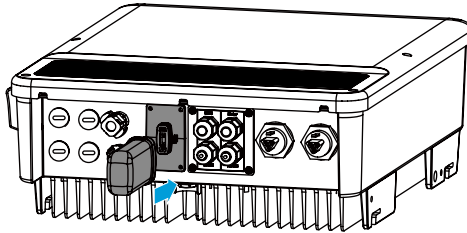

2.5 DRED & Remote Shutdown Connection

1. DRED(demand response enabling device) is only for Australian and New Zealand installations, in compliance with Australian and New Zealand safety requirements. And DRED is not provided
2. by manufacturer.
3. Remote shutdown is only for Europe installations, in compliance with Europe safety requirements. And Remote shutdown device is not provided by GoodWe.
4. Detailed operation is shown as below:

- 1 Screw this plate off from inverter.

Note: DRED device should be connected through "DRED port" as the figure shows.

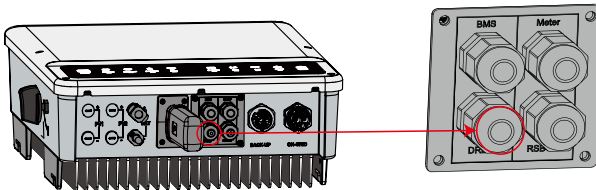

2

1. Plug out the 6-pin terminal and dismantle the resistor on it.
2. Plug the resistor out, leave the 6-pin terminal for next step.

Note:
The 6-pin terminal in the inverter has the same function of DRED device. Please leave it in the inverter if no external device connected.

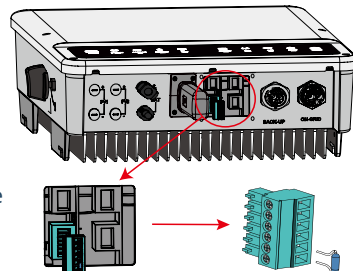

- 3 1. Put DRED cable through the plate.
2. Connect DRED cable on the 6-pin erminal.

For DRED:

- 1: DRM1/5
- 2: DRM2/6
- 3: DRM3/7
- 4: DRM4/8
- 5: REFGEN
- 6: COM/DRMO

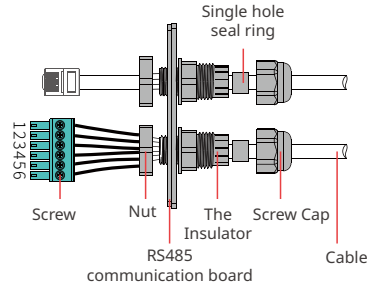

- 4 1. Put the cable through the plate.
2. Wiring from the No. 5 and 6 holes respectively.

For Remote ShutDown:

- 5: REFGEN
- 6: COM/DRMO

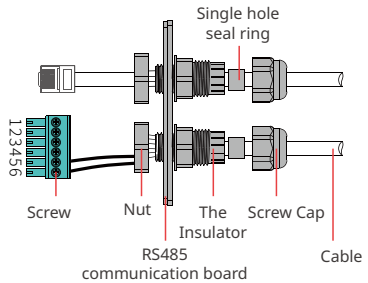

- 5 Connect the terminal to the right position onto the inverter.

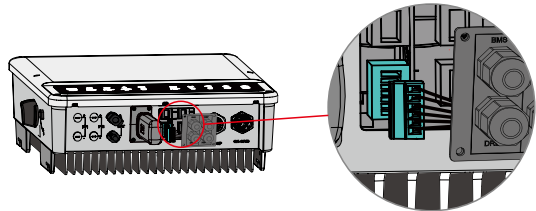

2.6 Earth Fault Alarm Connection

The inverter complies with IEC 62109-2 13.9. Fault indicator LED on inverter cover will light up and the system will email the fault information to customer.

Inverter should be installed at eye level for convenient maintenance.

Wiring system

Note: This diagram indicates the wiring structure of the inverter, not the electric wiring standard.

| Inverter | ① | ② | ③ | ④ | ⑤ |
|-----------|---------------------------|---------------------|---------------------|-------------------------------------|---|
| GW3K-BH | 40A/600V DC breaker | 50A/230V AC breaker | 32A/230V AC breaker | Depends on household loads | |
| GW3600-BH | | 50A/230V AC breaker | 32A/230V AC breaker | | |
| GW5000-BH | | 63A/230V AC breaker | 32A/230V AC breaker | | |
| GW6000-BH | | 63A/230V AC breaker | 40A/230V AC breaker | | |

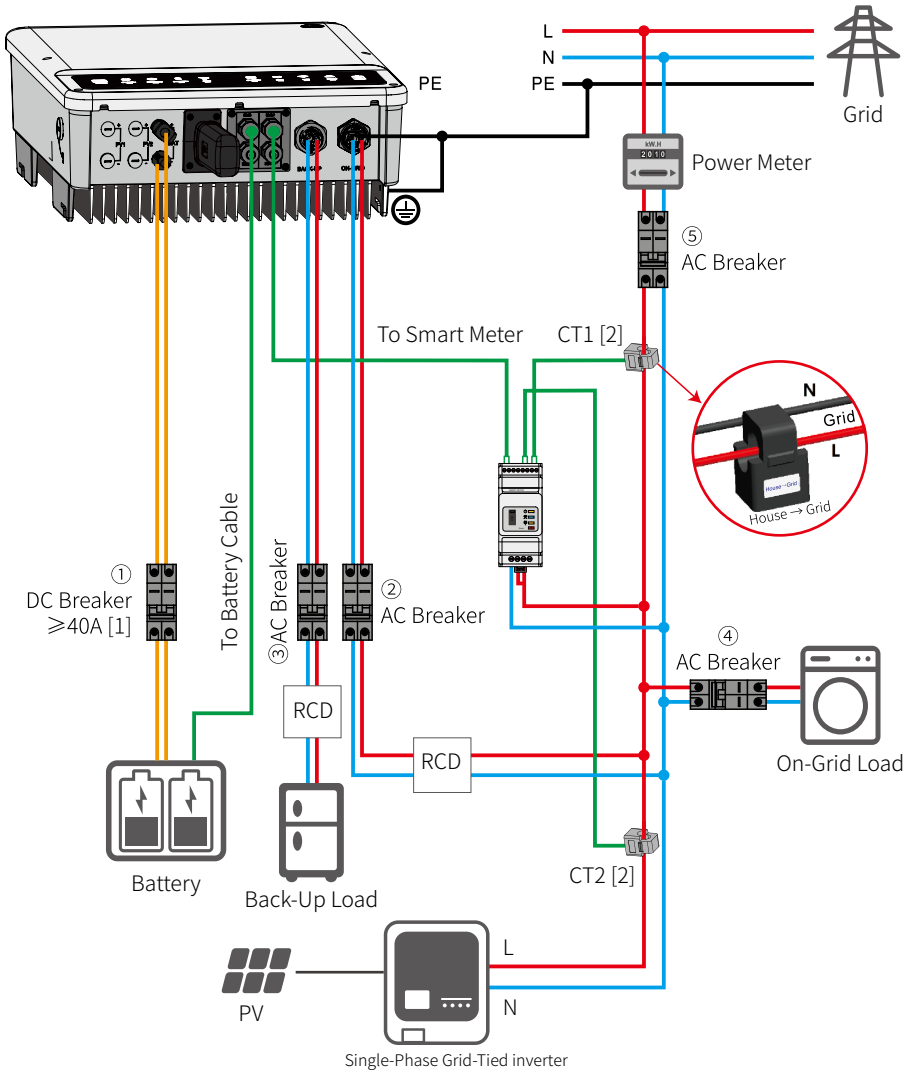

- [1] For batteries with attached switch, the external DC switch is not necessary.
- [2] Only for lithium battery which has BMS communication.
- [3] Direction of the CT cannot be connected in reverse, please follow "House > Grid" direction to do the connection.

For Spain Grid code, the output max. apparent power of GW6000-BH is 6KVA and will be less than

5KVA exported to grid limited by CT controller and power meter.

If the generation facility to be connected to the supply network with more than 5 kVA power in single phase, connection of the facility to the network shall be three-phase with an imbalance between phases of less than 5kW.

System connection diagrams

Note: According to Australian safety country, the neutral cable of on-grid side and back-up side must be connected together, otherwise back-up function will not work.

This diagram is an example for an application that neutral connects with the PE in a distribution box.

For countries such as Australia, New Zealand, South Africa, etc., please follow local wiring regulations!

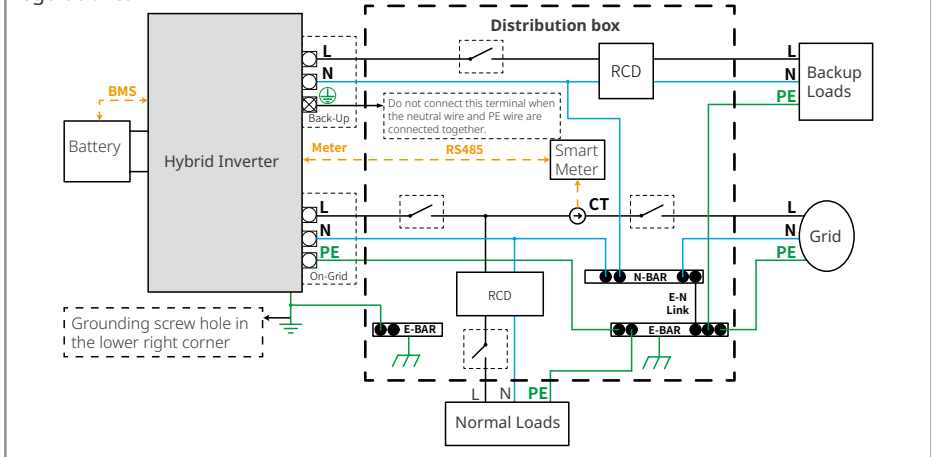

This diagram is an example for an application in which neutral is separated from the PE in the distribution box.

For countries such as China, Germany, the Czech Republic, Italy, etc., please follow local wiring regulations!

Note: Backup function is optional in German market. Please leave backup side empty if backup function is not available in the inverter.

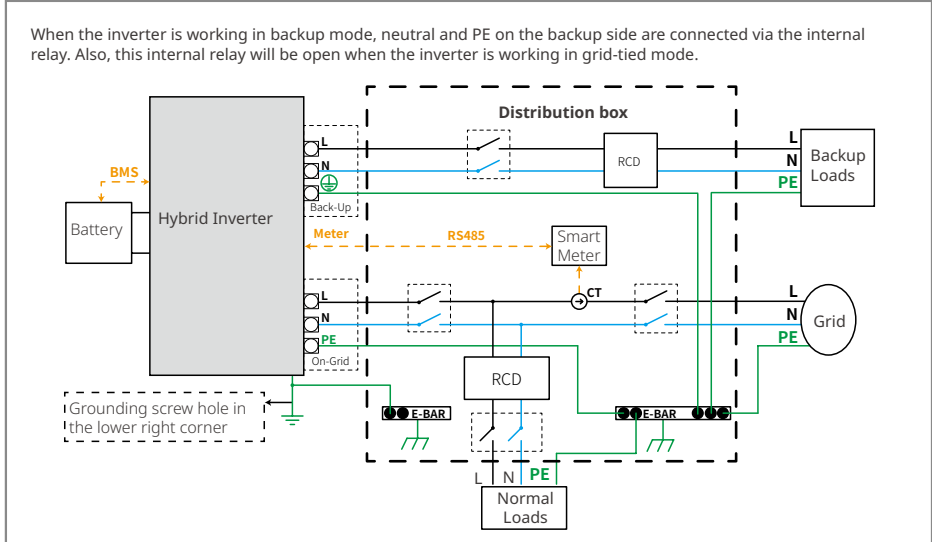

Note: After the inverter is installed and worked normal when the grid connected, please turn off the grid power to check whether the Back-Up function is normal, which can avoid the problems in subsequent uses.

03 Manual Operation

3.1 Wi-Fi Configuration

This part shows the configuration using a web page. Wi-Fi configuration is absolutely necessary for online monitoring and maintenance.

Preparation:

1. The inverter must be powered up with battery or grid power.
2. A router with internet access to the website www.semsportal.com is required.

1

1. Connect Solar-Wi-Fi* to your PC or smart phone (* its name is the last 8 characters of the inverter's serial number); Password:12345678.
2. Open your browser and logon to 10.10.100.253 Admin (User): admin; Password: admin.
3. Then click "OK".

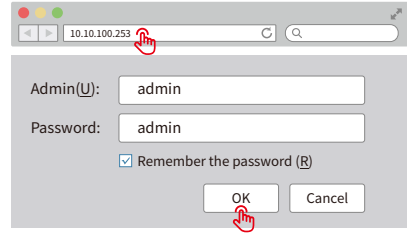

2

1. Click "Start Setup" to choose your router.
2. Then click "Next".

Device information

| | |
|----------------------|-------------------|
| Firmware version | 1.6.9.3.38.2.1.38 |
| MAC address | 60:C5:A8:60:33:E1 |
| Wireless AP mode | Enable |
| SSID | Solar-Wi-Fi |
| IP address | 10.10.100.253 |
| Wireless STA mode | Disable |
| Router SSID | WiFi_Burn-in |
| Encryption method | WAP/WAP2-PSK |
| Encryption algorithm | AES |
| Router Password | WiFi_Burn-in |

A "cannot join the network" error may be caused by:
No router, weak Wi-Fi signal, or the password is not correct

★ **Help:** The wizard will help you to complete setup within one minute.

Start Setup

Please select your current wireless network

| SSID | AUTH/ENCRY | RSSI | Channel |
|--------------------------------------|-----------------------|------|---------|
| <input type="radio"/> Wi-Fi_Burn-in | WPAPSKWPA2PSK/TKIPAES | 66 | 1 |
| <input type="radio"/> Wi-Fi_Burn-in | WPAPSKWPA2PSK/TKIPAES | 100 | 1 |
| <input type="radio"/> Wi-Fi_Burn-in | WPAPSKWPA2PSK/TKIPAES | 70 | 1 |
| <input type="radio"/> Wi-Fi_Burn-in2 | WPAPSKWPA2PSK/TKIPAES | 72 | 1 |

Refresh

★ **Help:** When the RSSI of the selected Wi-Fi network is below 15%, the connection may be unstable. Please select another available network or decrease the distance between the device and router. If your wireless router does not broadcast its SSID, please click "Next" and manually add the wireless network.

Back Next

3

1. Fill in the password of the router, then click "Next".
2. Click "Complete".

Add the wireless network manually

| | |
|----------------------|--------------|
| Network name (SSID) | Wi-Fi-Test |
| Encryption method | WPA/WPA2-PSK |
| Encryption algorithm | AES |

Please enter the wireless network password:

| | |
|----------------------------|-----------------|
| Password (8-63 characters) | Router password |
| | Show psk |

Note: The SSID and password are case sensitive. Please make sure all parameters of the wireless network match those of the router, including the password.

Back Next

Save success!

Click "Complete". the current configuration will take effect after a restart.

If you still need to configure the other pages of information, please proceed to complete your required configuration.

The configuration is complete. You can now log on to the Management page to restart the device by clicking on the "OK" button.

Click Confirm to complete?

Back Complete



Note:

1. Please make sure the password, Encryption method / algorithm is the same as the router's.
2. If everything is right well, the Wi-Fi LED on inverter will change from double blink to quartic blink then to solid status, which means Wi-Fi has connected to the server successfully.
3. WiFi configuration could also be done on PV Master App, details please check on PV Master App.

WiFi Reset & Reload

WiFi reset means restarting the WiFi module. The WiFi settings will automatically be reprocessed and saved. WiFi Reload means setting the WiFi module to the default factory settings.

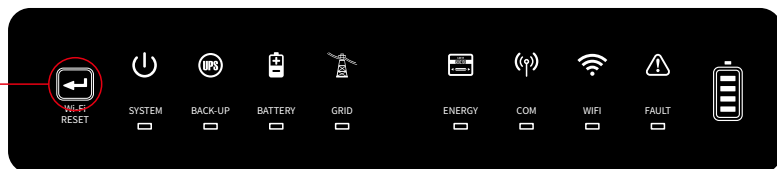

WiFi Reset Button

Do not press the button if WiFi monitoring is working correctly.

WiFi reset

Short press the reset button.
The WiFi LED will blink for a few seconds.

WiFi reload

Long press the reset button more than 3s.
The WiFi indicator will double blink until the WiFi is configured again.

Note:

The WiFi reset and reload function can be used only when:

1. WiFi disconnects with the internet or cannot connect successfully to the PV Master App.
2. "Solar-WiFi signal" cannot be found or other WiFi configuration problems exist.

3.2 PV Master

PV Master is an external monitoring and configuration application for hybrid inverters and is used on smart phones or tablets for both Android and iOS systems. The main functions are listed as below:

1. Configure the system to customize functions by the user.
2. Monitor and check the performance of the hybrid system.
3. Access and change the regional settings.
4. Check the inverter firmware version.
5. Set export power limit.

Search PV Master in Google Play or Apple App Store, or scan the QR code to download the app.

Operation steps are the same for Android system and iOS system although the two interfaces are slightly different.

For more detailed operation instructions, please refer to PV Master user manual in www.goodwe.com.



PV Master App

Special adjustable settings

The inverter has a field where the user can set functions, such as trip points, trip time, time of reconnection, active and invalid of QU curve, and PU curve. These functions can be adjusted by using special software. If interested, please contact the after-sales department.

Note:

For Australian customers please select from Australia Region A/B/C to comply with AS/NZS 4777.2:2020. Contact local grid operator to see which Region to select. After setting the safety region, some parameters in the inverter system will take effect according to the corresponding safety regulations, such as PU curve, QU curve, trip protection, etc. For Australian and European users, if you need to change the configuration parameters, please refer to the PV Master user manual.

3.3 SEMS Portal

SEMS Portal is an online monitoring system. After completing the installation of communication connection, you can access www.semsportal.com or download the app by scanning the QR code to monitor your PV plant and device.

Please contact the after-sales for more operation of SEMS Portal.



SEMS Portal App

3.4 CEI Auto-Test Function

The PV auto-test function of CEI is integrated into the PV Master App to satisfy Italian safety requirements. For detailed instructions regarding this function, please refer to "PV Master Operation Instructions".

3.5 Startup/shutdown Procedure

1. When you want to shut down the inverter during an event, you shall turn off the inverter DC switch and the battery DC breaker.
2. When you want to start-up the inverter after rectification, you shall turn on the inverter DC switch and the battery DC breaker.



04 Other

4.1 Error Messages.

The error messages below will be displayed on PV Master App or reported by e-mail if an error occurs.

| ERROR MESSAGE | EXPLANATION | REASON | SOLUTIONS |
|-----------------------|-----------------------------------------------------------------------------|----------------------------------------------------------------------------------------------------|--------------------------------------------------------------------------------------------------------------------------------------------------------------------------------------------------------------------------------------------------------------------------------------------------------------------------------------------------------------------------------------------------------------------------------------------------------------------------------------------------------------------------------------------------------------------------------------------------------------------------------------------------------------------------------------------|
| Utility Phase Failure | The sequence of the on-grid wire is incorrect | The inverter has detected that the phase angles of L2 and L3 are reversed | The L2 and L3 cables are connected in reverse order. |
| Utility Loss | Public grid power is not available (power lost or on-grid connection fails) | Inverter does not detect the connection of grid | <ol style="list-style-type: none"> 1. Check (use multi-meter) if AC side has voltage . Make sure grid power is available. 2. Make sure AC cables are connected tightly and well. 3. If all is well, please try to turn off AC breaker and turn on again in 5 mins. |
| VAC Failure | Grid voltage is not within permissible range | Inverter detects that AC voltage is beyond the normal range required by the safety country | <ol style="list-style-type: none"> 1. Make sure safety country of the inverter is set right. 2. Check (use multi-meter) if the AC voltage (Between L & N) is within a normal range (also on AC breaker side) <ol style="list-style-type: none"> a. If the AC voltage is high, then make sure the AC cable complies with that required on user manual and the AC cable is not too long. b. If the voltage is low, make sure the AC cable is connected well and the jacket of the AC cable is not compressed into the AC terminal. 3. Make sure the grid voltage of your area is stable and within normal range. |
| FAC Failure | Grid frequency is not within permissible range | Inverter detects that the grid frequency is beyond the normal range required by the safety country | <ol style="list-style-type: none"> 1. Make sure the safety country of the inverter is set right. 2. If safety country is right, then please check on the inverter display if AC frequency (Fac) is within a normal range. 3. If FAC failure only appears a few times and is resolved soon, it should be caused by occasional grid frequency instability. |

| | | | |
|--------------------|-----------------------------------------------------|------------------------------------------------------------------------------------------------------------------------------------------------------------------------------------------------------------|--------------------------------------------------------------------------------------------------------------------------------------------------------------------------------------------------------------------------------------------------------------------------------------------------------------------------------------------------------------------------------------------------------------------------------------------------------------------------------------------------------------------------------------------------------------------------------------------------------------------------------------------------------------------------|
| PV/BAT Overvoltage | The PV or BAT voltage is too high | The total voltage (open-circuit voltage) of each PV string is higher than the maximum DC input voltage of the inverter or the battery voltage is higher than the maximum BAT input voltage of the inverter | <ol style="list-style-type: none"> 1. Check if the PV string Voc is lower than the Max PV input voltage of the inverter. If the Voc of the PV string is high, please decrease the number of PV panels to make sure that Voc is within the maximum DC input voltage range of the inverter. 2. Check if the battery voltage is lower than the maximum battery input voltage of the inverter. If the battery voltage is high, please decrease the number of battery packs to make sure the voltage is within the maximum battery input voltage range of the inverter. |
| Over Temperature | Temperature inside of the inverter is too high | The inverter's working environment leads to a high temperature condition | <ol style="list-style-type: none"> 1. Try to decrease surrounding temperature. 2. Make sure the installation complies with the instruction on inverter user manual. 3. Try to close the inverter for 15 mins, then start up again. |
| Isolation Failure | Ground insulation impedance of PV string is too low | Isolation failure could be caused by multiple reasons like that the PV panels are not grounded well, DC cable is broken, PV panels are aged or surrounding humidity is comparatively heavy, etc. | <ol style="list-style-type: none"> 1. Use multi-meter to check if the resistance between earth & inverter frame is close to zero. If it's not, please ensure that the connection is well. 2. If the humidity is too high, isolation failure may occur. 3. Check the resistance between PV1+/PV2+/PV3+/PV4+/BAT+/PV- to earth. If the resistance is lower than the minimum isolation resistance shown in the table(chapter 2.4.2) , check the system wiring connection. 4. Try to restart the inverter. Check if the fault still occurs. If not, it means it is caused by an occasional situation, or contact after-sales |
| Ground Failure | Ground leakage current is too high | Ground failure could be caused by multiple reasons like that the neutral cable on the AC side is not connected well or the surrounding humidity is comparatively heavy, etc. | Check (use multi-meter) if there is voltage (normally should be close to 0V) between earth & inverter frame. If there is a voltage, it means the neutral & ground cables are not connected well on the AC side. If it happens only in the early morning/ dawn /rainy days with higher air humidity and is recovered soon, it should be normal. |

| | | | |
|---------------------|--------------------------------|-----------------------------------------------------------------------------------------|---------------------------------------------------------------------------------------------------------------------------------------------------------------------------------------------------------------------------------------------------------|
| Relay Check Failure | Self checking of relay failure | Neutral & ground cables are not connected well on AC side or just an occasional failure | Check (use multi-meter) if there is high voltage (normally should be lower than 10V) between N & PE cable on the AC side. If the voltage is higher than 10V, it means the Neutral & ground cable are not connected well on AC side or restart inverter. |
| DC Injection High | / | The inverter detects a higher DC component in AC output | .Try to restart the inverter,check if it still occurs.If not,it is just an occasional situation.Otherwise, contact after-sales immediately. |
| EEPROM R/W Failure | / | Caused by a strong external magnetic field etc. | Try to restart the inverter,check if it still occurs.If not,it is just an occasional situation.Otherwise, contact after-sales immediately. |
| SPI Failure | Internal communication failure | Caused by a strong external magnetic field etc. | Try to restart the inverter,check if it still occurs.If not,it is just an occasional situation.Otherwise, contact after-sales immediately. |
| DC Bus High | BUS voltage is over-high | / | Try to restart the inverter. Check if the fault still occurs. If not, it means it is caused by an occasional situation,or contact after-sales. |
| Back-Up Over Load | Back-up side is over loaded | Total back-up load power is higher than the back-up nominal output power | Decrease back-up loads to make sure the total load power is lower than back-up nominal output power. |

4.2 Troubleshooting

Checks Before Turning On AC Power

- **Battery connections:** Confirm that the connections between the inverter and battery and that the polarities (+/-) are not reversed. Refer to figure 4.2-1
- **On-grid & backup connections:** Confirm that the on-grid is connected to the power grid and that the backup is connected to the loads and that the polarities (e.g. L1/L2/L3/N are in sequence) are not reversed. Refer to figure 4.2-2.
- **Smart Meter & CT connections:** Make sure that the Smart Meter and CT are connected between the house loads and the grid and follow the Smart Meter direction sign on the CT. Refer to figure 4.2-3.

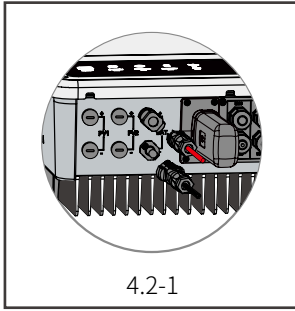

4.2-1

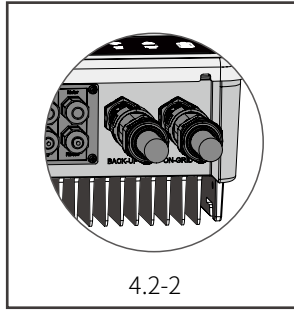

4.2-2

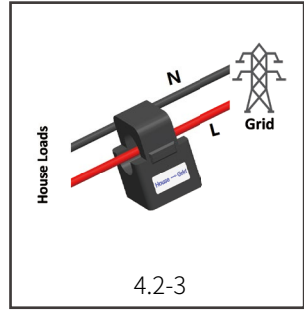

4.2-3

Checks At Startup And Turning On AC Power

Battery settings, BMS communication and safety country setting:

After connecting the Solar-Wi-Fi* (*The Wi-Fi signal is named as the last 8 characters of the inverter's serial number.). Check the PV Master App "Param" to make sure that the battery type is the same as was installed. Also check that the "Safety Country" setting is correct. If it is not correct, please set it correctly in "Set".

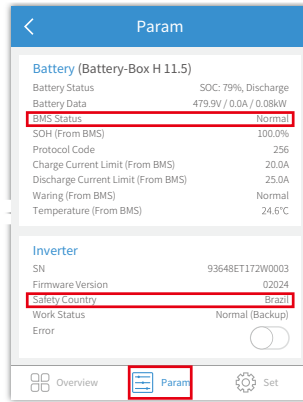
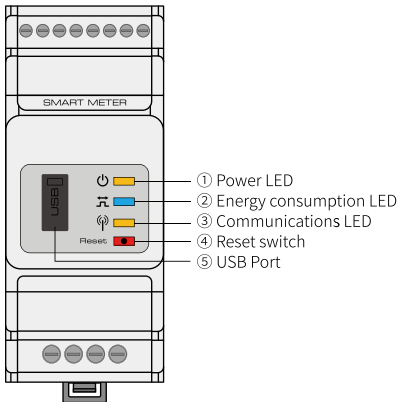

Note: For compatible lithium batteries, the BMS status will display "Normal" after selecting the correct battery company.

Problems During Operation

High Power Fluctuation on Battery Charge or Discharge:

Solution:

Check if there is a fluctuation on load power.

Battery Does Not Charge:

Solution:

1. Make sure BMS communication is OK on PV Master.
2. Check if CT connected in the right position and to right direction.

The battery does not charge when the PV power is greater than the load power

Solution:

1. Check the discharge time setting on the APP.
2. Check if the battery is fully charged and also if the battery voltage reaches the "charge voltage".

High power fluctuations during battery charge or discharge

Solution:

1. Check if there are fluctuations in load power.
2. Check if there are fluctuations in PV power.

Battery does not charge

Solution:

1. Make sure that BMS communications are OK on the PV Master App.
2. Check if the CT is connected at the right position and is connected in the right direction per the User Manual.
3. Check if the total load power is significantly higher than the PV power.

Questions & Answers (Q & A)

About the Wi-Fi Configuration

Q: Why can't I find the Solar-Wi-Fi* signal on mobile devices?

A: Normally the Solar-Wi-Fi* signal can be seen immediately after inverter has powered up. However, the Solar-Wi-Fi signal will disappear when the inverter connects to the internet. If changes to the settings are required to connect to the router for changes. If you cannot find the Wi-Fi signal or connect to the router, please try to reload the Wi-Fi.

Q: Why can't I connect to the Solar-Wi-Fi* signal on my phone?

A: The Wi-Fi module can only connect to one device at a time. If the signal is already connected to another device at the same time, you will not be able to connect to the signal.

About Battery Operation

Q: Why does the battery not discharge when the grid is not available but it discharges normally when the grid is available?

A: On the APP, the off-grid output and backup function should be turned on to force the battery to discharge under off-grid mode.

Q: Why is there no output on the backup side?

A: For backup supply, "Backup Supply" on the PV Master App must be turned on. In off-grid mode or when the grid power is disconnected, the "Off-Grid Output Switch" function must be turned on as well.

Note: When turning the "Off-Grid Output Switch" on, do not restart the inverter or battery. Otherwise, the function will be switched off automatically.

Q: Why does the battery SOC suddenly jump to 95% on the Portal?

A: This normally happens when BMS communications fail when using lithium batteries. If the batteries enter float charge mode, the SOC is automatically reset to 95%.

Q: The battery cannot be fully charged to 100%?

A: The battery will stop charging when the battery voltage reaches the charge voltage set in the PV Master App.

Q: Why does the battery switch always trip when it starts up (lithium battery)?

A: The switch of the lithium battery trips because of following reasons:

1. BMS communication fails.
2. The battery SOC is too low and the battery trips to protect itself.
3. An electrical short-circuit has occurred on the battery connection side. Alternatively, for other reasons, Please contact the after-sales department.

About PV Master Operation And Monitoring

Q: Why can't I save settings on the PV Master App?

A: This could be caused by losing the connection to Solar-Wi-Fi*.

1. Make sure you have already connected to Solar-Wi-Fi* (make sure that no other devices are connected) or to the router (if Solar-Wi-Fi* is connected to the router). The APP homepage shows the connections.

2. Make sure you restart the inverter 10 mins after you have changed any settings because the inverter will save the settings every 10 mins while operating in normal mode. We recommend that parameter settings be changed when the inverter is in wait mode.

Q: Why are the data displayed on the homepage different from the param page, like charge/discharge, PV value, load value, or grid value?

A: The data refresh frequency is different, so there will be data discrepancies between different pages on the APP as well as between these shown on the portal and APP.

Q: Some columns show NA, like battery SOH, etc. Why does that happen?

A: NA means that the App has not received data from the inverter or server because of communication problems, such as battery communications and the communications between inverter and the App.

About the Smart Meter And Power Limit Function

Q: How to activate the output power limit function?

A: For the inverter system, this function can be activated by following these steps:

1. Make sure the Smart Meter connections and communications are functioning correctly.
2. Turn on the export power limit function and set the maximum output power to the grid on the APP.

Note: Even if the output power limit is set to 0W, there might still be a deviation of a maximum of 100 W when exporting to the grid.

Q: Can I use other meter brands to take over from the Smart Meter in the system or to change settings in Smart Meter?

A: No, because the communication protocol is integrated into the inverter and Smart Meter, other meter brands cannot communicate. Also, any change to the manual settings could cause a meter communication failure.

Q: What is the maximum current allowed to pass through the CT on the Smart Meter?

A: The maximum current for the CT is 120A.

Other Questions

Q: What kind of load can I use to connect to the backup side?

A: Please refer to On-Grid&Back-Up Connection section.

Q: Will the warranty of the inverter still be valid if, for some special conditions, we cannot follow 100% of the User Manual instructions for installation or operation?

A: Normally we still provide technical support for problems caused by not following the instructions in the User Manual. However we cannot guarantee any replacements or returns. So, if there are any special conditions for which you cannot follow the instructions 100%, please contact the after-sales department for suggestions.

4.3 Disclaimer

The inverters are transported, used and operated under environmental and electrical conditions. The manufacturer has the right to not provide after-sales services or assistance under the following conditions:

- The inverter is damaged during transfer.
- The inverter is out of the warranty year and an extended warranty is not purchased.
- The inverter is installed, refitted, or operated in improper ways without authorization from the manufacturer.
- The inverter is installed or used under improper environmental or technical conditions (as mentioned in this User Manual) and without authorization from manufacturer.
- The installation or configuration of the inverter does not follow the requirements mentioned in this User Manual.
- The inverter is installed or operated contrary to the requirements or warnings mentioned in this User Manual.
- The inverter is broken or damaged by any force majeure, such as lightning, earthquake, fire hazard, storm and volcanic eruption etc.
- The inverter is disassembled, changed or updated on software or hardware without authorization from the manufacturer.
- The Inverter is installed, used, or operated against any related provisions contained in international or local policies or regulations.
- Any incompatible batteries, loads or other devices are connected to the system.
- Specifications are subject to change without notice. Every effort has been made to make this document complete, accurate and up-to-date. However, GoodWe may need to make some improvements under certain circumstances without advance notice. GoodWe shall not be responsible for any loss caused by this document including, but not limited omissions errors, typographical errors, arithmetical errors or listing errors in this document. If you have any questions or suggestions, please contact GoodWe after-sale.

Note: The manufacturer retains the right to explain all of the contents in this User Manual. To insure IP66, the inverter must be sealed well; please install the inverters within one day of unpacking; otherwise, please seal all unused terminals /holes; unused terminals/holes are not allowed to remain open; and confirm that there is no risk of water or dust entering any terminals/holes.

Maintenance

| Maintaining Item | Maintaining Method | Maintaining Period |
|-----------------------|--------------------------------------------------------------------------------------------------------------------------------------------------------------|--------------------|
| System Clean | Check the heat sink, air intake, and air outlet for foreign matter or dust. | Once 6-12 months |
| Electrical Connection | Check whether the cables are securely connected. Check whether the cables are broken, or whether there is any exposed copper core. | Once 6-12 months |
| Sealing | Check whether all the terminals and ports are properly sealed. Reseal the cable hole if it is not sealed or too big. | Once a year |
| THDi Test | For Australia requirements, in the THDi test, there should add Zref between inverter and mains. RA=0, 24; XA=j0,15 at 50Hz; RN=0, 16; XN=j0,10 at 50Hz | As needed |

WiFi module: Replace or remove the WiFi module using the WiFi module remover, which is delivered in the package. Remove the communication terminal next to the WiFi module first. Place the remover horizontally on the WiFi module, then turn the remover to 90° to fasten it and the module together. Press the remover and pull the module to remove it as the following figure shows.

Notice: If you need to repair or replace parts, contact the after sales service.

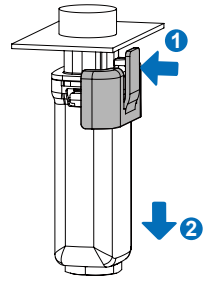

4.4 Technical Parameters

| Technical Data | GW5K-BT | GW6K-BT | GW8K-BT | GW10k-BT |
|-------------------------------------------------------|----------------------|---------|---------|----------|
| Battery Input Data | | | | |
| Battery Type | Li-Ion | | | |
| Nominal battery voltage (V) | 500 | | | |
| Battery Voltage Range (V) | 180~600 | | | |
| Max. Charging Current (A) | 25 | | | |
| Max. Discharging Current (A) | 25 | | | |
| Max charge power (W) | 5000 | 6000 | 8000 | 10000 |
| Max discharge power (W) | 5000 | 6000 | 8000 | 10000 |
| Charging Strategy for Li-Ion Battery | Self-adaption to BMS | | | |
| AC Output Data (On-grid) | | | | |
| Nominal Apparent Power Output to Utility Grid (VA) | 5000 | 6000 | 8000 | 10000 |
| Max. Apparent Power Output to Utility Grid (VA) *1 *6 | 5500 | 6600 | 8800 | 11000 |
| Nominal Apparent Power from Grid(VA) | 10000 | 12000 | 15000 | 15000 |
| Max. Apparent Power from Utility Grid (VA) | 10000 | 12000 | 15000 | 15000 |
| Nominal Output Voltage (V) | 400/380, 3L/N/PE | | | |
| Output Voltage Range (V) | 0~300 | | | |
| Nominal Output Frequency (Hz) | 50/60 | | | |
| AC Grid Frequency Range (Hz) | 45~55 | | | |
| Nominal Output Current (A) | 7.2 | 8.7 | 11.6 | 14.5 |
| Max. AC Current Output to Utility Grid (A) | 8.5 | 10.5 | 13.5 | 16.5 |
| Max. AC Current From Utility Grid (A) | 15.2 | 18.2 | 22.7 | 22.7 |
| Max. Output Fault Current(peak and duration) (A) | 45,2us | | | |
| Inrush Current(peak and duration) (A) | 45,2us | | | |
| Maximum output overcurrent protection (A) | 45,2us | | | |

| | | | | |
|--------------------------------------------------|-------------------------------------------------|--------------|--------------|--------------|
| Output Power Factor | ~1 (Adjustable from 0.8 leading to 0.8 lagging) | | | |
| Output THDi (@Nominal Output) | <3% | | | |
| AC Output Data (Back-up) | | | | |
| Back-up Nominal apparent power (VA) | 5000 | 6000 | 8000 | 10000 |
| Max. Output Apparent Power (VA) | 5000 | 6000 | 8000 | 10000 |
| Peak Output Apparent Power (VA) *2 | 10000, 60sec | 12000, 60sec | 15000, 60sec | 15000, 60sec |
| Nominal Output Current (A) | 7.2 | 8.7 | 11.6 | 14.5 |
| Max. Output Current (A) | 8.5 | 10.5 | 13.5 | 16.5 |
| Max. Output Fault Current(peak and duration) (A) | 45,2us | | | |
| Inrush Current(peak and duration) (A) | 45,2us | | | |
| Maximum output overcurrent protection (A) | 45,2us | | | |
| Nominal Output Voltage (V) | 400/380 | | | |
| Nominal Output Frequency (Hz) | 50/60 | | | |
| Output THDv (@Linear Load) | <3% | | | |
| Efficiency | | | | |
| Max. Battery to Load Efficiency | 97.6% | 97.6% | 97.6% | 97.6% |
| Max. Charge Efficiency | 97.6% | 97.6% | 97.6% | 97.6% |
| Max. Efficiency | 97.6% | 97.6% | 97.6% | 97.6% |
| European Efficiency | 97.2% | 97.2% | 97.5% | 97.5% |
| Protection | | | | |
| Anti-islanding Protection | Integrated | | | |
| Insulation Resistor Detection | Integrated | | | |
| Residual Current Monitoring Unit | Integrated | | | |
| Output Over Current Protection | Integrated | | | |
| Output Short Protection | Integrated | | | |
| Battery Input Reverse Polarity Protection | Integrated | | | |
| Output Over Voltage Protection | Integrated | | | |

| General Data | |
|----------------------------------------------------|---------------------------------------------------|
| Operating Temperature Range (°C) | -35~60 |
| Relative Humidity | 0~95% |
| Operating Altitude (m) | ≤ 4000 |
| Cooling | Nature Convection |
| Noise (dB) | <30 |
| User Interface | LED & APP |
| Communication with BMS ^{*3} | RS485; CAN |
| Communication with Meter | RS485 |
| Communication with EMS | RS485 (Insulated) |
| Communication with Portal | Wi-Fi/LAN |
| Weight (kg) | 21 |
| Size (Width*Height*Depth mm) | 415*516*180 |
| Mounting | Wall Bracket |
| Protection Degree | IP66 |
| Standby Self Consumption (W) ^{*4} | <15 |
| Topology | Battery Non-Isolation |
| DC Connector | MC4(4~6mm ²) |
| AC Connector | Feed-Through Terminal Blocks UW10 |
| Environmental Category | 4K4H |
| Storage environments(°C) | -40~85°C |
| Pollution Degree | III |
| Protective class | Class I |
| Overvoltage Category | DCII; ACIII |
| The Decisive Voltage Class (DVC) | Battery: C; AC: C ; COM: A |
| Active anti-islanding method | AFDPF+AQDPF ^{*7} |
| Type of electrical supply system | Three phase TN/TT system |
| Certifications & Standards^{*5} | |
| Grid Regulation | VDE-AR-N4105; EN 50549-1 G98,G99 G100;CEI 0-21 |
| Safety Regulation | IEC/EN 62477 |

| | |
|----------------------------------------------------------------------------------------------------------------------------------------------------------------------------------------------------------------------------------------------------------------------------------------------------------------------------------------------------------------------------------------------------------------------------------------------------------------------------------------------------------------------------------------------------------------------------------------------------------------------------------------------------------------------------------|----------------------------------------------------------------------------------------------|
| EMC | EN61000-6-1, EN61000-6-2, EN61000-6-3, EN61000-6-4, EN61000-4-16, EN61000-4-18, EN61000-4-29 |
| <p>*1: According to the local grid regulation.</p> <p>*2: Can be reached only if battery capacity is enough, otherwise will shut down.</p> <p>*3: CAN communication is configured by default. If 485 communication is used, please replace the corresponding communication line.</p> <p>*4: No Back-up Output.</p> <p>*5: Not all certifications & standards listed, check the official website for details.</p> <p>*6: For Belgium Max. Apparent Power Output to Utility Grid (VA): GW5K-BT is 5000; GW6K-BT is 6000; GW8K-BT is 8000; GW10K-BT is 10000.</p> <p>*7: AFDPF: Active Frequency Drift with Positive Feedback, AQDPF: Active Q Drift with Positive Feedback</p> | |

4.4 Quick Checklist To Avoid Dangerous Conditions

1. The inverter must not be installed near flammable or explosive materials or near equipment with strong electromagnetic fields.
2. Remember that this inverter is heavy! Please be careful when lifting from the package.
3. Make sure that the battery breaker is off and that the nominal battery voltage meets specifications before connecting the battery to the inverter; make sure that the inverter is totally isolated from both PV and AC power.
4. Make sure that the inverter is totally isolated from all DC or AC power before connecting the AC cable.
5. Make sure the AC cable is totally isolated from AC power before connecting the Smart Meter and CT.



Appendix

Protection category definition

Moisture location category definition

| Moisture Parameters | Level | | |
|---------------------|---------|-----------|-----------|
| | 3K3 | 4K3 | 4K4H |
| Temperature Range | 0~+40°C | -33~+40°C | ~20~+55°C |
| Moisture Parameters | 5%~85% | 15%~100% | 4%~100% |

Environment category definition

| Environment Condition | Ambient Temperature | Relative Humidity | Applied to |
|-----------------------|---------------------|-------------------|------------|
| Outdoor | -20~50°C | 4%~100% | PD3 |
| Indoor Unconditioned | -20~50°C | 5%~95% | PD3 |
| Indoor conditioned | 0~40°C | 5%~85% | PD2 |

Overvoltage category definition

| | |
|---------------------|-----------------------------------------------------------------------------------------------------------------------------------------------------------------------------------------------------------------------------------------------------------------|
| Category I | Applies to equipment connected to a circuit where measures have been taken to reduce transient overvoltage to a low level. |
| Category II | Applies to equipment not permanently connected to the installation. Examples are appliances, portables tools and other plug-connected equipment. |
| Category III | Applies to a fixed equipment downstream, including the main distribution board. Examples are switchgear and other equipment in an industrial installation. |
| Category IV | Applies to equipment permanently connected at the origin of an installation (upstream of the main distribution board). Examples are electricity meters, primary over-current protection equipment and other equipment connected directly to outdoor open lines. |

Pollution degree definition

| | |
|-----------------------------|-----------------------------------------------------------------------------------------------------------------------------------------|
| Pollution Degree I | No pollution or only dry, non-conductive pollution occurs. The pollution has no influence. |
| Pollution Degree II | Normally only non-conductive pollution occurs. Occasionally, however, a temporary conductivity caused by condensation must be expected. |
| Pollution Degree III | Conductive pollution occurs, or dry, non-conductive pollution occurs, which becomes conductive due to condensation, which is expected. |
| Pollution Degree IV | Persistent conductive pollution occurs, for example, the pollution caused by conductive dust, rain or snow. |

JIANGSU GOODWE POWER SUPPLY TECHNOLOGY CO.,LTD

 No. 90 Zijin Rd., New District, Suzhou, 215011, China

 www.goodwe.com

 service@goodwe.com



Local Contacts